

These dial-in-handset common battery type telephone sets mount either as desk sets or wall sets. They are shipped wired for individual line or bridged ringing subscriber service. Wiring can be changed to provide Ring party flat rate service, Tip party flat rate service, use with 1A type Key system and use with speakerphone system. Special line cord must be ordered when 1A type Key telephone or Speaker phone system is used.

The Handset contains a recall button that allows a new number to be dialled without replacing the handset in the on-hook position. A volume control wheel is located at the right side of the telephone near the rear of the base and can be adjusted up or down by rotating the wheel. Volume control can be adjusted by the installer so that the ringer will be completely silenced when the subscriber moves the control wheel fully toward the low volume position. Has a secure off-hook position for both wall and desk mounted sets. Each set has a five and a half foot retractable NE-H5QE handset cord.

[Back to Index](#)

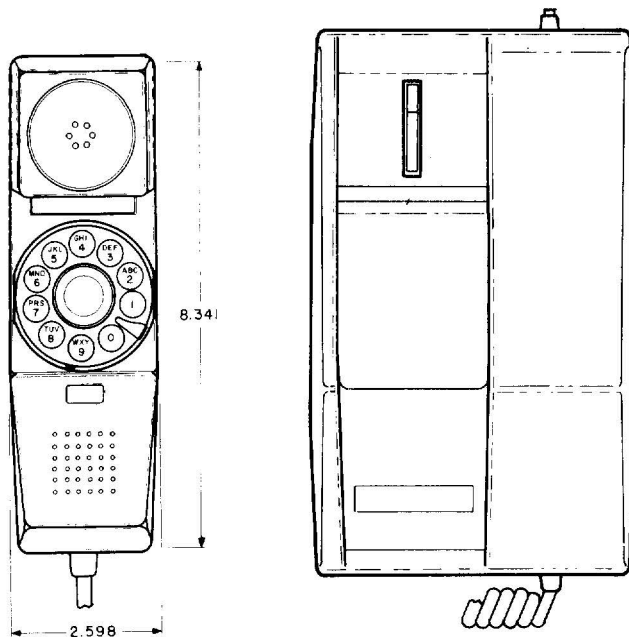

QSK-100A: Equipped with a QNB18A Network, an NE-D1QA Ringer an dial-in-handset telephone has miniaturized dial for compact handset.

- * Available in a range of colours, as indicated on colour Card M, and when ordering the appropriate suffix number denoting the desired available colour should be added.

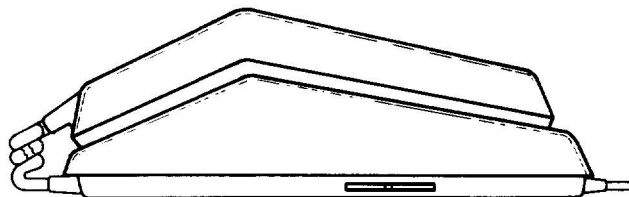

Back to Index



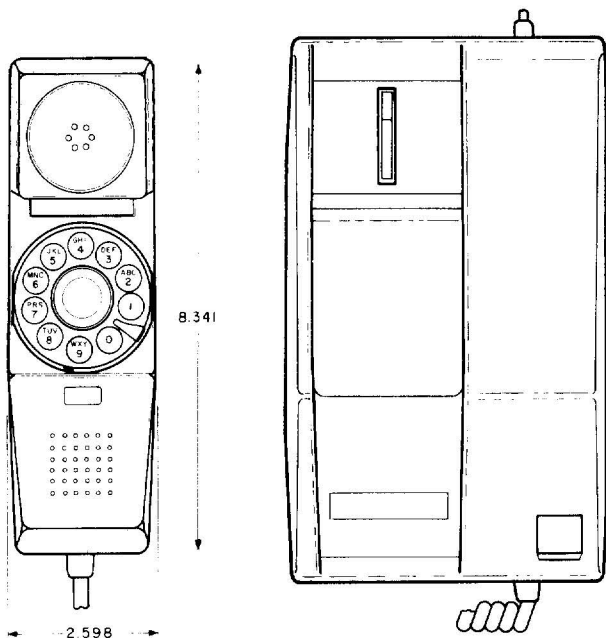

QSK100B: Equipped with a QNB18A Network, a NE-D1QA Ringer, an NE-D3Q5A line cord and an NE-H1QA Handset. Designed specifically for use in Hotels, motels and other guest accommodation, as part of a telephone message waiting system. When a message is taken at the central desk, the attendant activates a lamp which illuminates a red lens on the right front corner of the telephone set in the guests room. The light will continue to flash until the message is received.

* Available in a range of colours, as indicated on colour Card M, and when ordering, the appropriate suffix number denoting the desired available colour should be added.

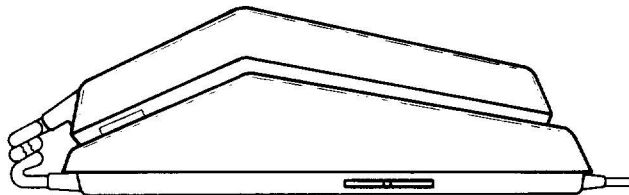

Back to Index



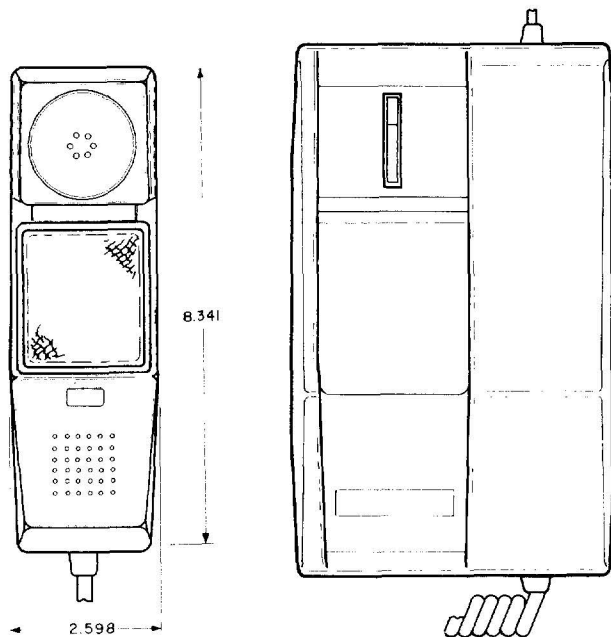

QSK100C: Equipped with a QNB18A network, a NE-D1QA ringer, and NE-D3Q5A line cord, and a NE-H3QA Handset. These No-Dial Telephone sets have a softly padded charcoal grey insert in the area normally occupied by the dial.

Initially intended as hotel house phones, at airport terminals for car rental or taxi tie-line service.

* Available in a range of colours, as indicated on colour Card M, and when ordering, the appropriate suffix number denoting the desired available colour should be added.

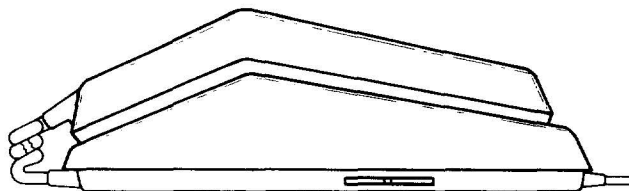

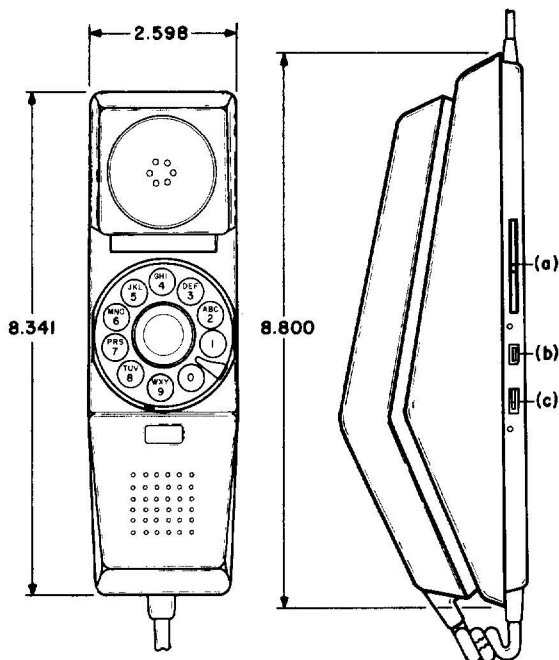

HAND SET
(SHOWING DIAL)

- (a) VOLUME CONTROL
(b) SIGNALLING SWITCH
(c) LINE SELECTOR

This dial-in-handset common battery type telephone set mounts either as a desk or wall set. Shipped wired for individual line or bridged ringing subscriber service. Wiring can be changed to provide Ring party flat rate service, Tip party flat rate service, use with 1A type Key system and use with speakerphone system. Special line cord must be ordered when 1A type Key telephone or Speaker phone system is used.

The Handset contains a recall button that allows a new number to be dialled without replacing the handset in the on-hook position. A volume control wheel is located at the right side of the telephone near the rear of the base and can be adjusted up or down rotating the wheel. Volume control can be adjusted by the installer so that the ringer will be completely silenced when the subscriber moves the control wheel fully toward the low volume position. Has a secure off-hook position for both wall and desk mounted sets.

This two line version of the CONTEMPRA telephone set is equipped with a two line slide switch and a grounding or signalling switch. Also contains an NE-H1QA handset, an NE-D6QB line Cord, an NE-D1QA Ringer and a QNB18B Network.

Available in a range of colours, as indicated on colour card M, and when ordering, the appropriate suffix number denoting the desired available colour should be added.

Back to Index



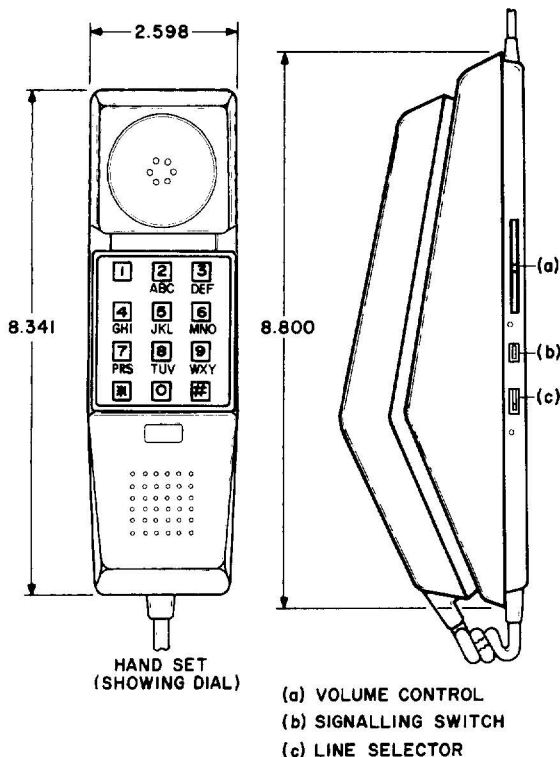

This dial-in-handset common battery type telephone set mounts either as a desk or wall set. It is shipped wired for individual line or bridged ringing subscriber service. Wiring can be changed to provide ring party flat rate service, tip party flat rate service, use with 1A type Key system and use with speakerphone system. Special line cord must be ordered when 1A type key telephone or speakerphone system is used.

Designed with a recall button that allows a new number to be dialled without replacing the handset in the on-hook position. A volume control wheel is located at the rear base of the set and it can be adjusted by the installer so that it is completely silenced when the subscriber moves the wheel fully toward the low volume position. Has a secure off-hook position for both wall and desk mounted sets.

This two line version of the CONTEMPRA telephone set has a DIGITONE dial as well as a two line slide switch and a grounding or signalling switch. Also contains an NE-H2QA Handset, an NE-D6QB line cord, and NE-D1QA Ringer and a QNB18B Network.

Available in a range of colours as indicated on colour Card M, and when ordering, the appropriate suffix number denoting the desired available colour should be added.

Back to Index



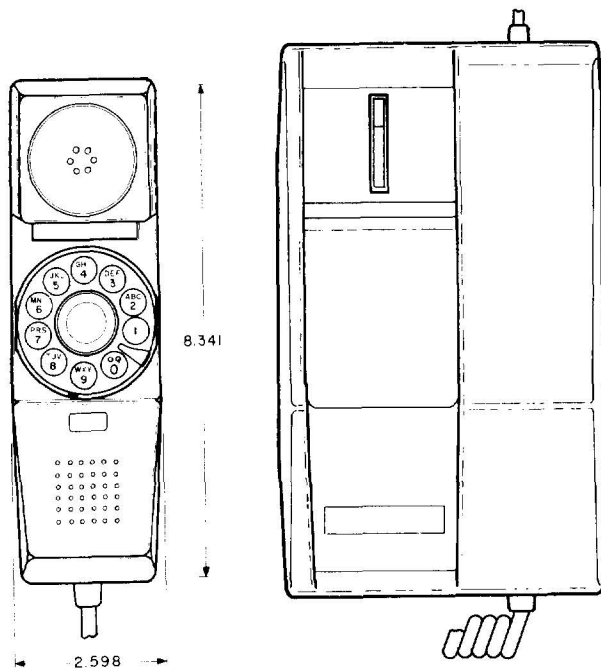

QSK100D: Equipped with a QNB59A Network, a QRS4A Ringer, a NE-D3Q5A line cord and a NE-H1QC Handset.

Initially required for N.E.I. (France)

-
- * Available in a range of colours, as indicated on colour Card N, and when ordering, the appropriate suffix number denoting the desired available colour should be added.

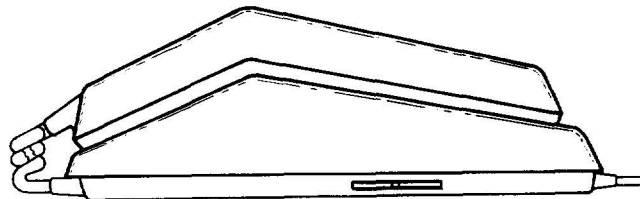

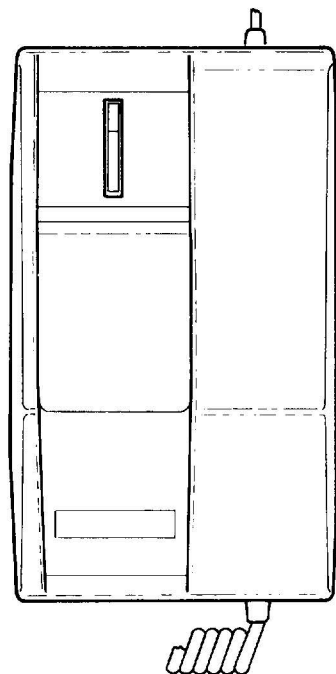
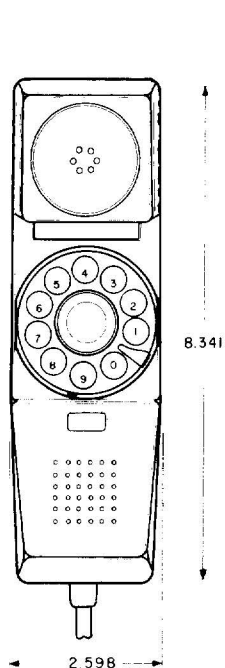

QSK100E: Equipped with a QNB18D Network, a QRS4A high sensitivity ringer an NE-D3Q5A line cord and an NE-H1QD Handset, which includes an all number calling, NE-10QB dial. Set up for offshore locations with a TC 1000 transmission circuit.

Initially required for Venezuela.

-
- * Available in a range of colours, as indicated on colour Card N, and when ordering, the appropriate suffix number denoting the desired available colour should be added.

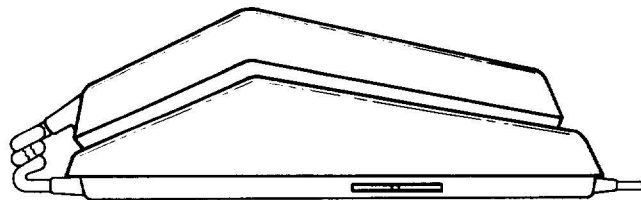

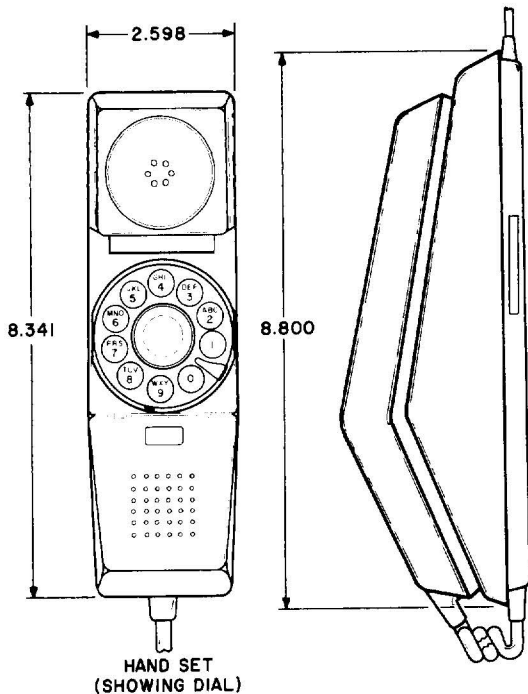

This dial-in-handset common battery type telephone set mounts either as a desk or wall set. It is shipped wired for individual line or bridged ringing subscriber service. Wiring can be changed to provide ring party flat rate service, tip party flat rate service, use with 1A type key system and use with speakerphone system. Special line cord must be ordered when 1A type key telephone or speakerphone system is used.

Designed with a recall button that allows a new number to be dialled without replacing the handset in the on-hook position. A volume control wheel is located at the rear base of the set and it can be adjusted by the installer so that is completely silenced when the subscriber moves the wheel fully towards the low volume position. Has a secure off-hook position for both wall and desk mounted sets.

Contains an NE-H1QA Handset, an NE-H5QE handset cord, and NE-D3Q5A line cord, a QNB18A network and a mounting bracket to permit mounting of an M type ringer. (Ringer not supplied, must be ordered separately).

Available in a range of colours as indicated on colour Card N, and when ordering, the appropriate suffix number denoting the desired available colour should be added.

Back to Index

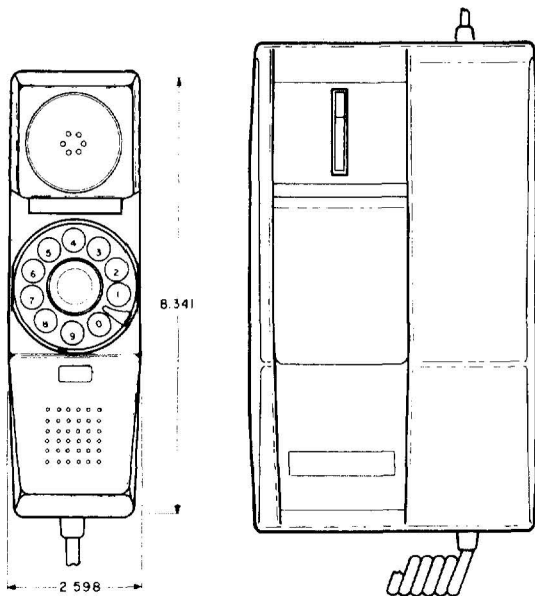

QSK100H: Equipped with a QNB18A Network, an NE-D1QA Ringer and an NE-10QB all Number Dial.

Available in a range of colours, as indicated on colour Card R, and when ordering the appropriate suffix number denoting the desired available colour should be added.

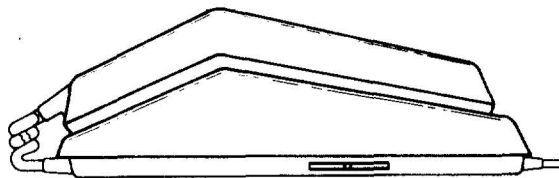

These dial-in-handset common battery type telephone sets mount either as desk sets or wall sets. They are shipped wired for individual line or bridged ringing subscriber service. Wiring can be changed to provide Ring party flat rate service, Tip party flat rate service, use with 1A type Key system and use with speakerphone system. Special line cord must be ordered when 1A type Key telephone or Speaker phone system is used.

The Handset contains a recall button that allows a new number to be dialled without replacing the handset in the on-hook position. A volume control wheel is located at the right side of the telephone near the rear of the base and can be adjusted up or down by rotating the wheel. Volume control can be adjusted by the installer so that the ringer will be completely silenced when the subscriber moves the control wheel fully toward the low volume position. Has a secure off-hook position for both wall and desk mounted sets. Each set has a five and a half foot retractable NE-H5QE handset cord.

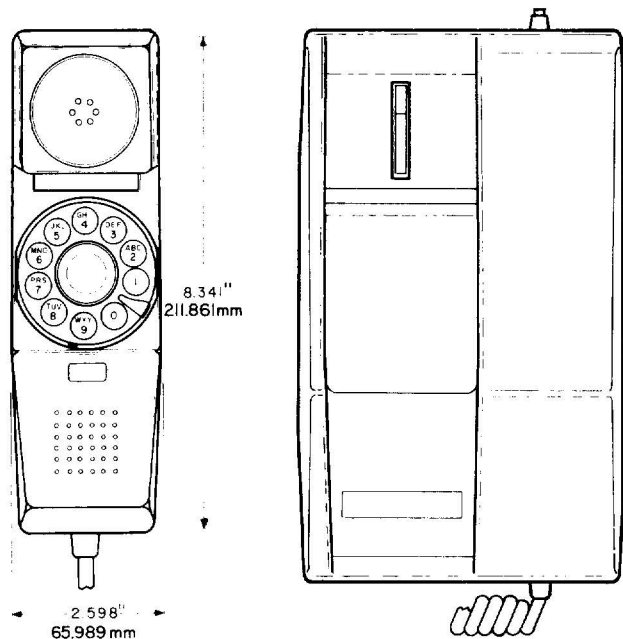

QSK100AX: Equipped with a QNB18A Network, NE-D1QA Ringer, NE-D3Q5A line cord and a NE-H1QAX Handset which has a miniaturized dial.

* Available in a range of colours, as indicated on Colour Card M, and when ordering the appropriate suffix number denoting the desired available colour should be added.

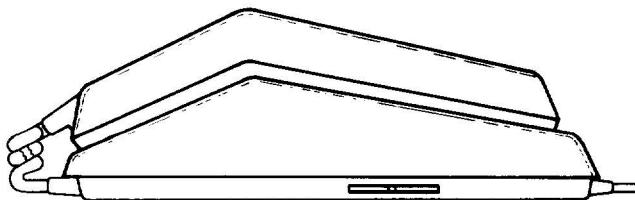

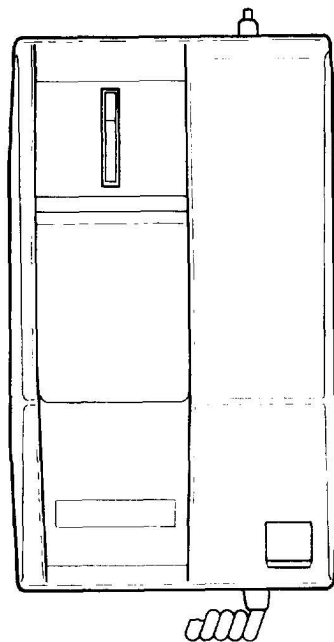
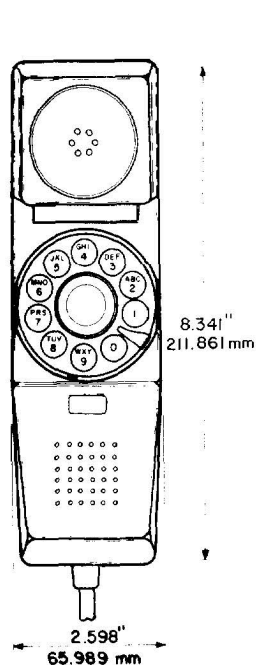

QSK100B: Equipped with a QNB18A Network, an NE-D1QA Ringer, an NE-D3Q5A line cord and an NE-H1QA Handset. Designed specifically for use in hotels, motels and other guest accommodation, as part of a telephone message waiting system. When a message is taken at the central desk, the attendant activates a lamp which illuminates a red lens on the right front corner of the telephone set in the guest's room. The light will continue to flash until the message is received.

* Available in a range of colours, as indicated on colour card M, and when ordering, the appropriate suffix number denoting the desired available colour should be added.

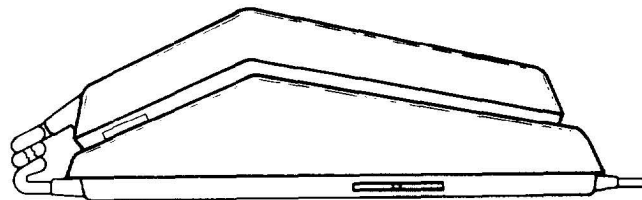

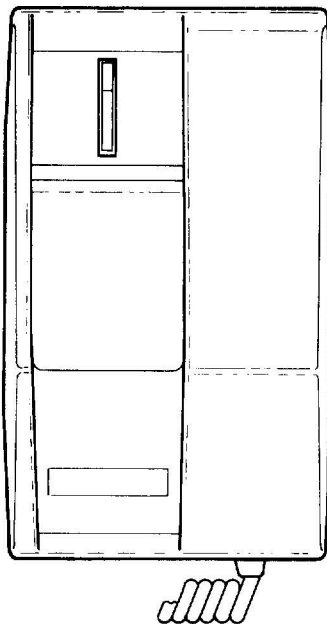
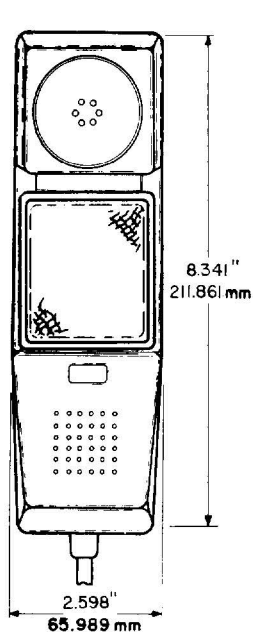

QSK100C: Equipped with a QNB18A Network, a NE-D1QA Ringer, and NE-D3Q5A line cord, and a NE-H3QA Handset. These No-Dial Telephone sets have a softly padded charcoal grey insert in the area normally occupied by the dial.

Initially intended as hotel house phones, at airport terminals for car rental or taxi teline service.

* Available in a range of colours, as indicated on colour Card M, and when ordering, the appropriate suffix number denoting the desired available colour should be added.

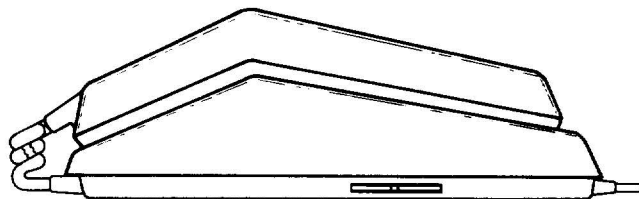

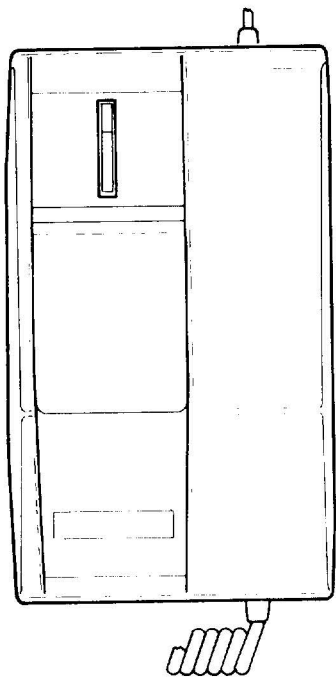
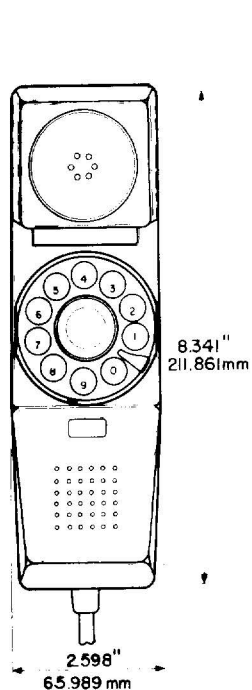

QSK100E: Equipped with a QNB18D Network, a QRS4A high sensitivity Ringer and NE-D3Q5A line cord and an NE-H1QD Handset, which includes an all number calling, NE-10QB dial. Set up for offshore locations with a TC 1000 transmission circuit.

Initially required for Venezuela.

* Available in a range of colours, as indicated on colour Card M, and when ordering, the appropriate suffix number denoting the desired available colour should be added.

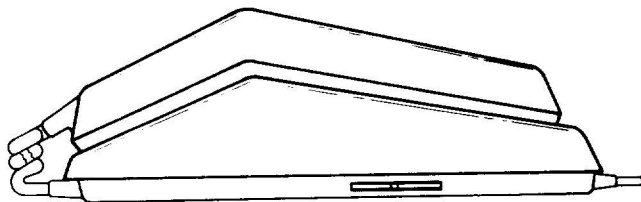

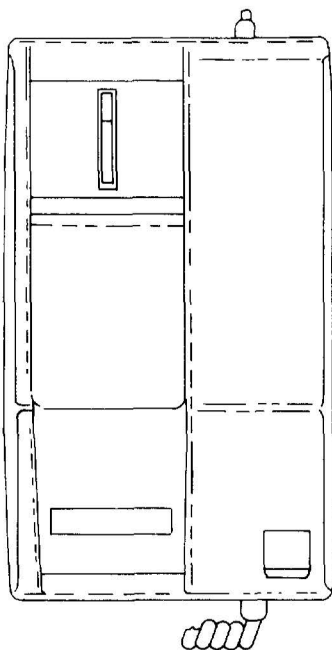
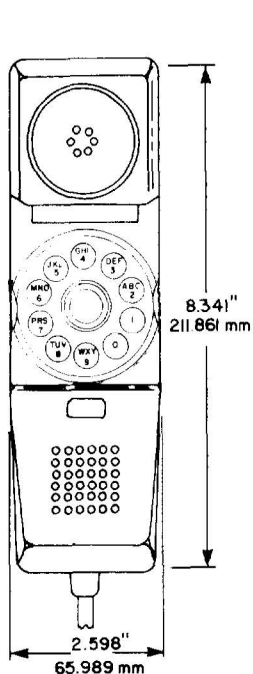

QSK100GX: Rotary Contempra Telephone Set suitable for two and four party service with automatic number identification capability. Recall Button breaks both the tip and ring of the line when depressed.

Equipped with a QNB18A network, an NE-D1QA ringer, NE-D3Q5A line cord and an NE-H1QJX handset.

*Available in a range of colours as indicated on Colour Card M, and when ordering the appropriate suffix numbers denoting the desired available colour should be added.

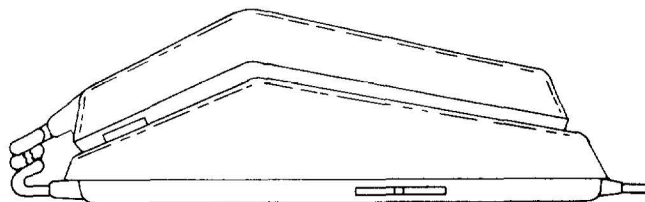

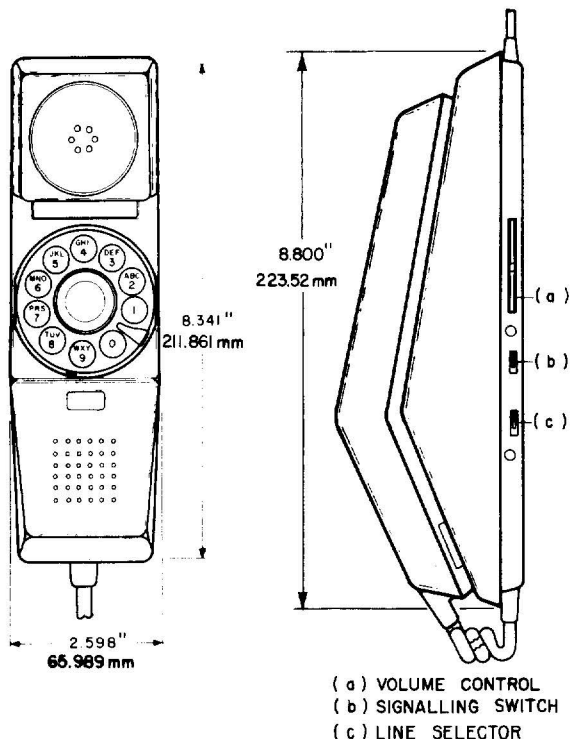

This dial-in-handset common battery type telephone set mounts either as a desk or wall set. Shipped wired for individual line or bridged ringing subscriber service. Wiring can be changed to provide Ring party flat rate service, Tip party flat rate service, use with 1A type Key system and use with speakerphone system. Special line cord must be ordered when 1A type Key telephone or Speaker phone system is used.

The Handset contains a recall button that allows a new number to be dialled without replacing the handset in the on-hook position. A volume control wheel is located at the right side of the telephone near the rear of the base and can be adjusted up or down rotating the wheel. Volume control can be adjusted by the installer so that the ringer will be completely silenced when the subscriber moves the control wheel fully toward the low volume position. Has a secure off-hook position for both wall and desk mounted sets.

This two line version of the CONTEMPRA telephone set is equipped with a two line slide switch and a grounding or signalling switch. Also contains an NE-H1QA handset, an NE-D6QB line cord, an NE-D1QA Ringer and a QNBI8B Network.

Available in a range of colours, as indicated on colour card M, and when ordering, the appropriate suffix number denoting the desired available colour should be added.

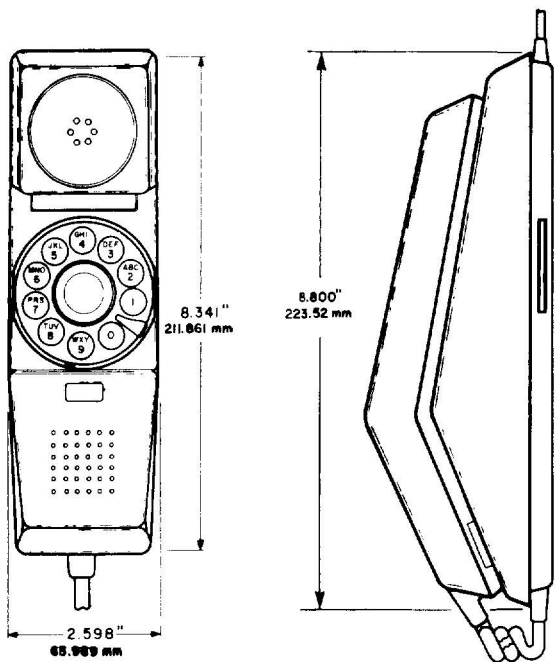

This dial-in-handset common battery type telephone set mounts either as a desk or wall set. It is shipped wired for individual line or bridged ringing subscriber service. Wiring can be changed to provide ring party flat rate service, tip party flat rate service, use with 1A type key system and use with speakerphone system. Special line cord must be ordered when 1A type key telephone or speakerphone system is used.

Designed with a recall button that allows a new number to be dialled without replacing the handset in the on-hook position. A volume control wheel is located at the rear base of the set and it can be adjusted by the installer so that it is completely silenced when the subscriber moves the wheel fully towards the low volume position. Has a secure off-hook position for both wall and desk mounted sets.

Contains an NE-H1QA Handset, an NE-H5QE handset cord, and NE-D3Q5A line cord, a QNB18A network and a mounting bracket to permit mounting of an M type ringer. (Ringer not supplied, must be ordered separately).

CODE	COLOUR	RATING
QSK191AX-26	Cocoa Brown	Standard
QSK191AX-31	Harvest Gold	Standard

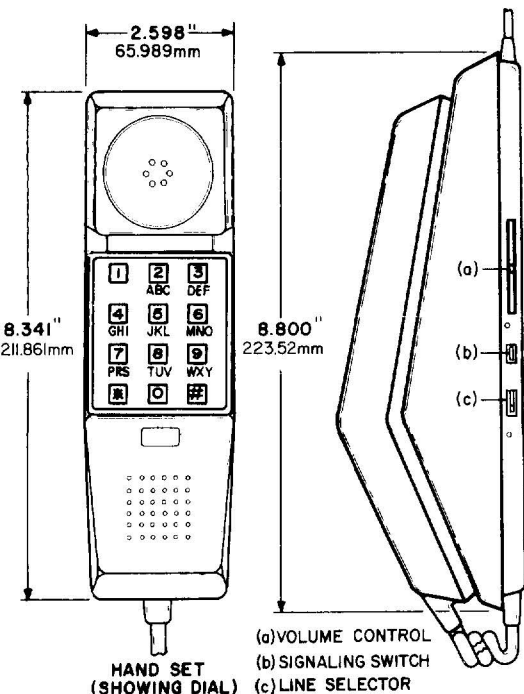

This dial-in-handset common battery type telephone set mounts either as a desk or wall set. It is shipped wired for individual line or bridged ringing subscriber service. Wiring can be changed to provide ring party flat rate service, tip party flat rate service, use with 1A type Key system and use with speakerphone system. Special line cord must be ordered when 1A type key telephone or speakerphone system is used.

Designed with a recall button that allows a new number to be dialled without replacing the handset in the on-hook position. A volume control wheel is located at the rear base of the set and it can be adjusted by the installer so that it is completely silenced when the subscriber moves the wheel fully toward the low volume position. Has a secure off-hook position for both wall and desk mounted sets.

This two line version of the CONTEMPRA telephone set has a DIGITONE dial as well as a two line switch and a grounding or signalling switch. Also contains an NE-H2QA Handset, an NE-D6QB line cord, and NE-D1QA Ringer and a QNB18B Network.

Available in a range of colours as indicated on Colour Card M, and when ordering, the appropriate suffix number denoting the desired available colour should be added.

Back to Index

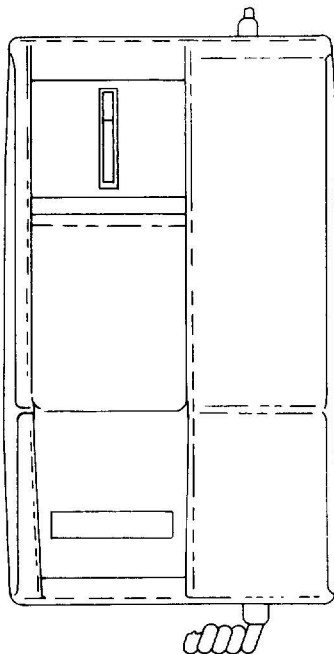
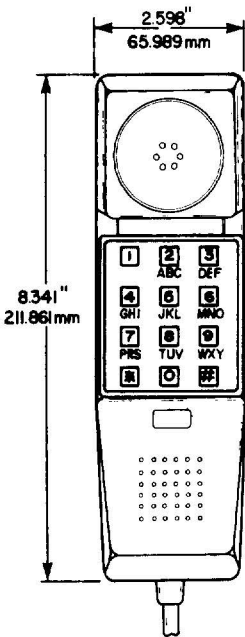

QSK2100AX: Equipped with a QNB18AN Network, NE-D1QA Ringer, NE-D3Q5A Line Cord and an NE-H2QAX Handset. Similar to the QSK100AX Telephone Set except handset has a DIGITONE dial. See card on QSK100 Type Telephone Sets for general information.

Available in a range of colours, as indicated on Colour Card M, and when ordering the appropriate suffix number denoting the desired available colour should be added.

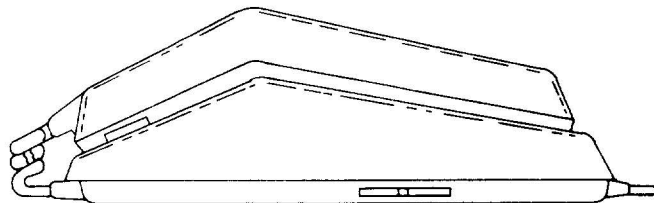

Back to Index

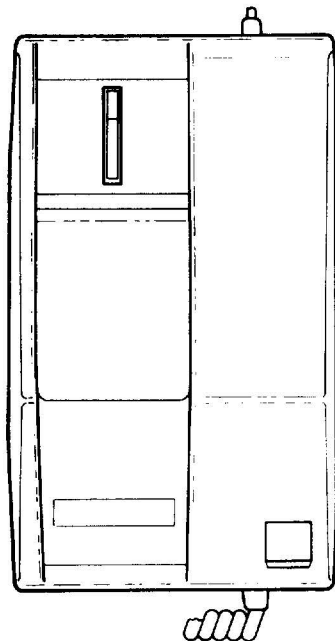
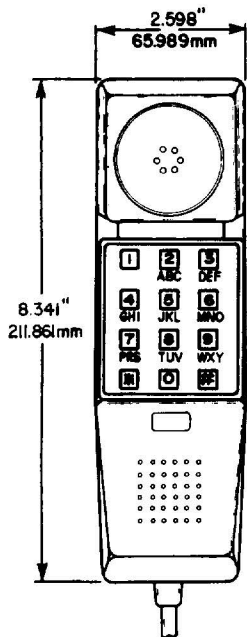

QSK2100BX: DIGITONE CONTEMPRA Telephone Set designed specifically for use in hotels, motels and other guest accommodation, as part of a telephone message waiting system. When a message is taken at the central desk, the attendant activates a lamp which illuminates a red lens on the right front corner of the telephone set in the guest's room. The light will continue to flash until the message is received.

Equipped with a QNB18A Network, NE-D1QA Ringer NE-D3QA Line Cord, NE-H2QAX Handset and an NPS25008 neon lamp. See card on QSK100 Type Telephone Sets for general information.

Available in a range of colours as indicated on Colour Card M, and when ordering the appropriate suffix number denoting the desired available colour should be added.

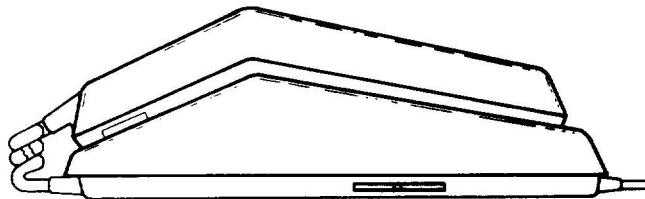

Back to Index

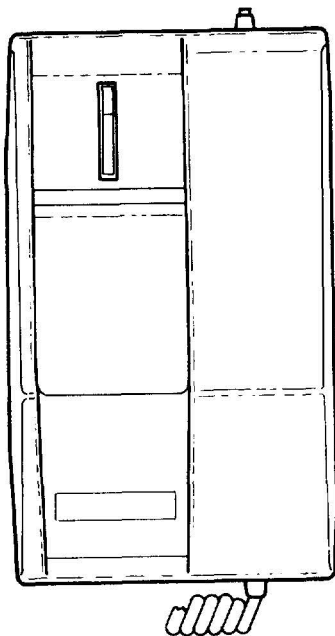
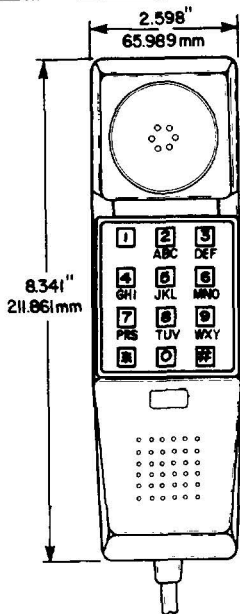

QSK2100GX: DIGITONE CONTEMPRA Telephone Set suitable for two and four party service with automatic number identification capability. Recall button breaks both the tip and ring of the line when depressed.

Equipped with a QNB18A Network, NE-D1QA Ringer NE-D3Q5A Line Cord and an NE-H2QFX Handset. See card on QSK100 Type Telephone Sets for general information.

Available in a range of colours as indicated on Colour Card M, and when ordering the appropriate suffix number denoting the desired available colour should be added.

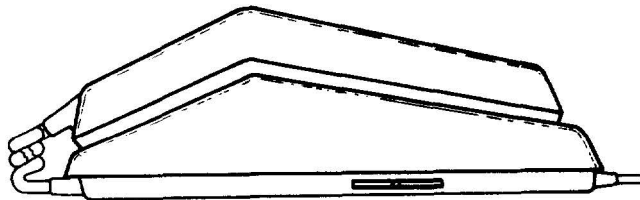

Back to Index