



**AASTRA**

## USER'S GUIDE

**THE RING SELECTOR**  
**LE TRIEUR DE SONNERIES**

Aastra Telecom

C1148 Rev-1.1

## 1 INTRODUCTION

The Ring Selector (RS) is a device which works in conjunction with the Ident-A-Call\* service. In order to use the features of the RS, you must subscribe to this service with your telephone company. The Ident-A-Call service allows you to have two (2) to three (3) telephone numbers on a single telephone line. Different ringing sequences are associated with each telephone number.



Ring Pattern 1:	primary number, one ring pulse
Ring Pattern 2:	second number, two ring pulses
Ring Pattern 3:	third number, three ring pulses

When the RS is connected to your telephone or fax, it will allow only the selected ringing sequence to pass through the module while blocking all others. The RS is designed to be used with different telephony devices such as telephones, modems, faxes and answering machines. It is ideal for home office, business or family use.

## 2 INSTALLATION

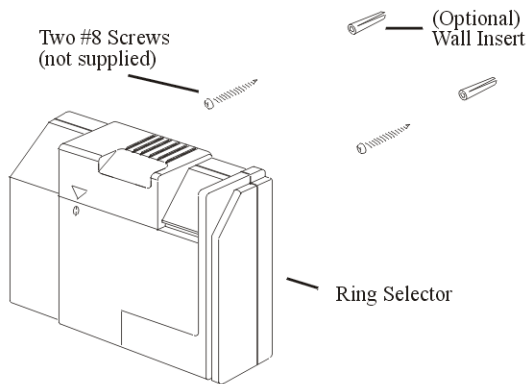
The Ring Selector (RS) can be wall mounted. At a location near a telephone wall jack, drive two #8 screws about 1 inch long into the wall 7 cm. (2 3/4 in.) apart. The Ring Selector (RS) simply clips onto the two screws. The use of wall inserts or anchors is optional.



Connect the Ring Selector's jack port, designated  to the wall outlet and the phone port designated  to the telephony device (phone, fax, modem or answering

See Section 3, Basic Operation, for switch setting instructions.

Telephony device - shown below is a fax machine.

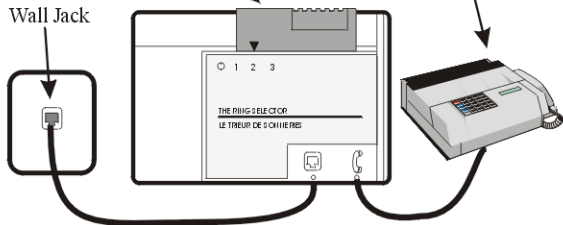

## 3 BASIC OPERATION

The Ring Selector (RS) has four position settings:

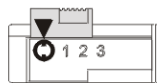

Allows all rings to pass through. Behaves as though the Ring Selector is not



Allows only the distinctive ring characterized by one (1) ring pulse to pass through.



Allows only the distinctive ring characterized by two (2) ring pulses to pass through.



Allows only the distinctive ring characterized by three (3) ring pulses to pass through.

Once you have connected the RS as shown in Section 2 and selected one of the above settings, the RS will automatically pass the selected ring through while blocking all others. However, the RS controls only what is connected to the output port. Therefore, extension phones not connected to a RS will behave as if there is no RS in the System.

The following is an operating characteristic when the switch is set to either 1, 2 or 3.

The RS suppresses and analyses the first ring cycle.



# 4

## HOME OFFICE OPERATION

### Scenario A:

- Situation:**
- Two telephone numbers, one line
  - Primary number for voice
  - Second number for fax

- Solution:**
- Attach Ring Selector as shown (right)
  - Set Switch to the "2" position
  - Set fax on "fax only" mode
  - Set fax to receive after 1 or 2 rings

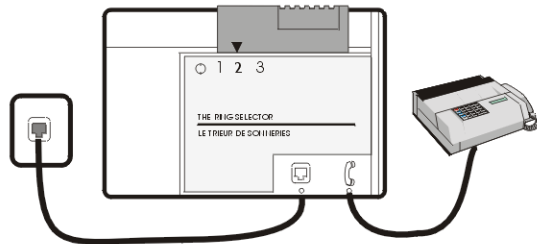

### Scenario B:

- Situation:**
- Situation same as Scenario A
  - Primary number uses an answering machine as shown in schematic (right)

- Solution:**
- Install as in Scenario A
  - Set answering machine to pick-up after 4 or more rings

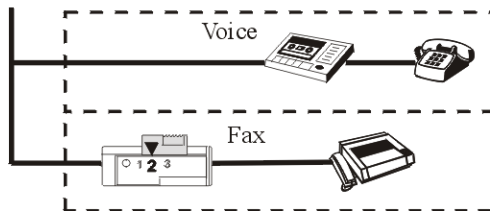

**Notes:** In this situation, when a fax call comes in, because the ring delay set on the answering machine is greater than on the fax, the fax machine will pick the call up before the answering machine. On the other hand, when a voice call comes in, the Ring Selector will block the call from the fax machine.

### Scenario C:

- Situation:**
- Situation same as Scenario A
  - The bedroom extension phone to ring only for voice calls (primary number).

- Solution:**
- Purchase 2 Ring Selectors
  - Install as in Scenario A for Fax
  - Attach the 2nd Ring Selector to bedroom phone as shown (right) and set switch to the "1" position.

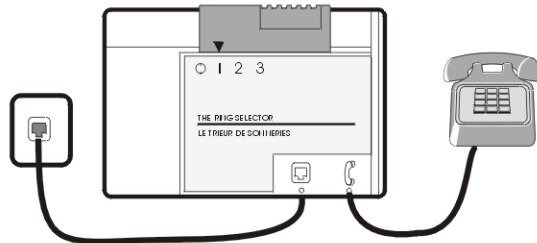

# 5

## FAMILY/ROOMMATES

Ideal for families with teenage children, live-in grandparents or nannies, and for households with roommates.

Just plug in one of these handy devices at each extension where you want to limit the type of calls that ring through. Set the switch to ring type 1, 2 or 3, and from now on, only calls with that type of ring will ring at that location.

For those occasions when you do want to hear all the calls at that location, just slide the switch to "0" and all calls will ring at that extension.

